

MY5076.1.2.4

YAPRAK MENTEŞE (50*76mm-Krom Kapl.-Delikli)
LEAF HINGE (50*76mm-Chrome Plated-Hole)

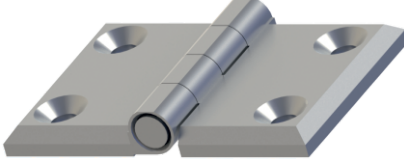

250Kg.

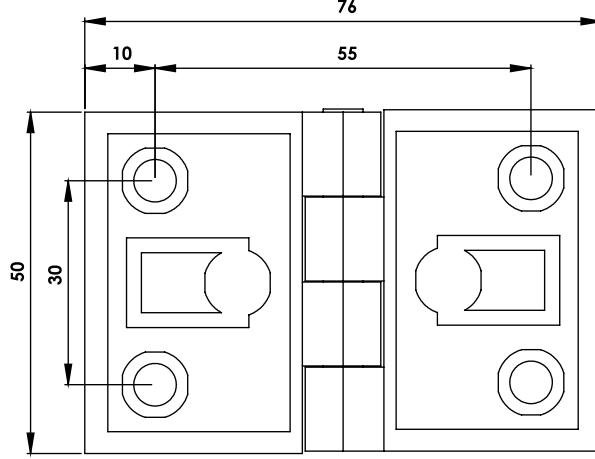

MY5076.1.5.4

YAPRAK MENTEŞE (50*76mm-Boyalı-Delikli)
LEAF HINGE (50*76mm-Black Coated-Hole)



250Kg.

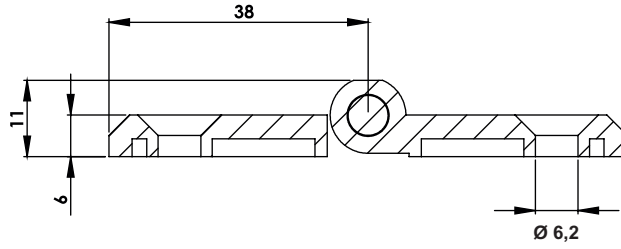

Kullanım Alanları

- * Elektrik Panoları
- * Makine Kapakları

Malzeme

- * Gövde: Zamak
DIN-EN 1774-ZnAl4Cu1
- * Pim :Çelik St 37
- * 2: Kaplama: Krom
- * 5: Kaplama: Boyalı
- * Menteşe Dönme Açısı: 180 '

Applications

- * Electric Panels
- * Machinery Covers

Material

- * Body: Zamak
DIN-EN 1774-ZnAl4Cu1
- * Pin : Steel St 37
- * 2: Finish: Chrome
- * 5: Finish: Black Coated
- * Hinge Rotation Angle: 180 '

